

Assembly Instructions

Bed - Double Mirage Platform

ROPO no:

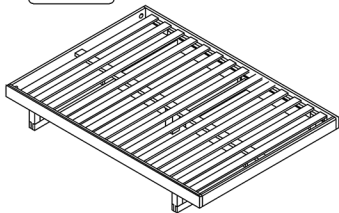

FUTON
C O M P A N Y



PLEASE READ THESE INSTRUCTIONS VERY CAREFULLY BEFORE YOU BEGIN, TO ENSURE THAT YOUR FUTON COMPANY PRODUCT WILL GIVE YOU MANY YEARS OF SATISFACTION

Thank you for buying a Futon Company product.

We are constantly striving to improve everything we do, but occasionally mistakes do occur. In the unlikely event that you find any part missing, please call your nearest Futon Company store and we will arrange for the despatch of an immediate replacement. Please keep all packaging until you have checked every part and assembly of your Futon Company product is complete.

Version number: 1

Product code: BD4 MIRAGE

Date: 23/07/15

experts in small space living



Parts Checklist





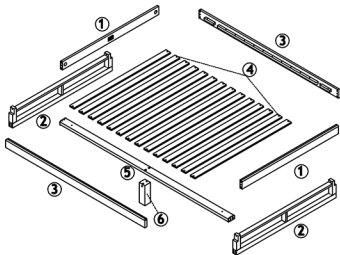





Please count and check every component very carefully before you begin

- ① End Rail x 2
- ② End Board x 2
- ③ Long Rail x 2
- ④ Slats x 14
- ⑤ Middle Support Rail x 1
- ⑥ Middle Support Block x 1



Fittings Checklist

Please count and check every component very carefully before you begin

- 

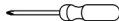

- a Wooden Dowel x 8 b Bolt x 4 c Pressure Plate x 4 d Allen Nut x 4
- 

- e Small Spanner x 1 f Screw x 28 g Allen Head Bolt x 2 (m6x60)
- 



- h Allen Key x 1 k Barrel Nut x 2 l Felt protector pad x 4 m Allen Head Bolt x 4 (m6x45)



* Cross head Screwdriver also required for assembly



How To Assemble Your Bed

Please follow these instructions carefully

FUTON C O M P A N Y



How To Use

Please read carefully

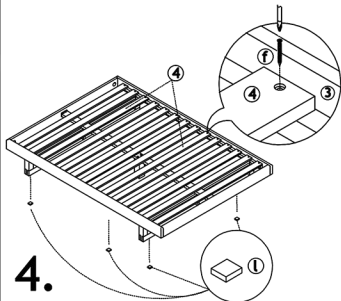
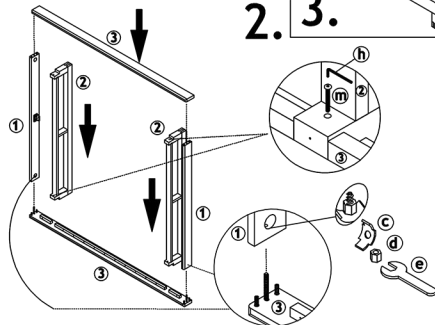
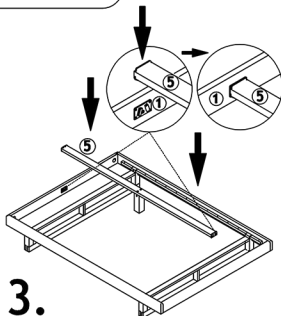
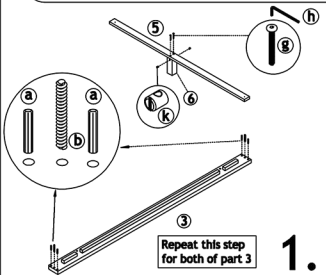

FINISH

Timber may be selected to ensure that the visible surfaces are of a higher grade than unseen surfaces. These unseen areas are not finished to the same standard as the visible surfaces.

CARE

To clean your Bed, wipe with a damp cloth followed by a dry cloth.

IMPORTANT

To ensure maximum performance from this product, we advise that you check and tighten all bolts and screws on a regular basis to avoid damage and strain to parts.

GUARANTEE

This instruction leaflet forms part of your guarantee. Please retain it. The ROPO number along with your invoice number will need to be quoted in all correspondence with Futon Company.

Thank you for choosing Futon Company.